

Data Sheet

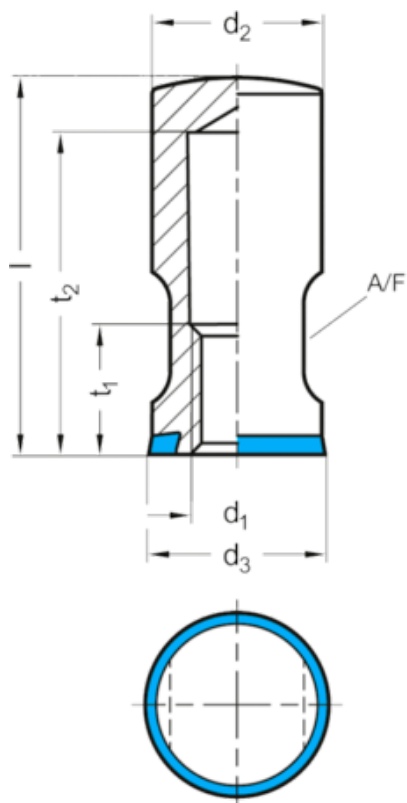

Article number: 20201M2068H
Description: GN 20.1-M20-68-H
Stainless Steel-Cover sleeves
Note: Hygienic Design

Measures



Application example

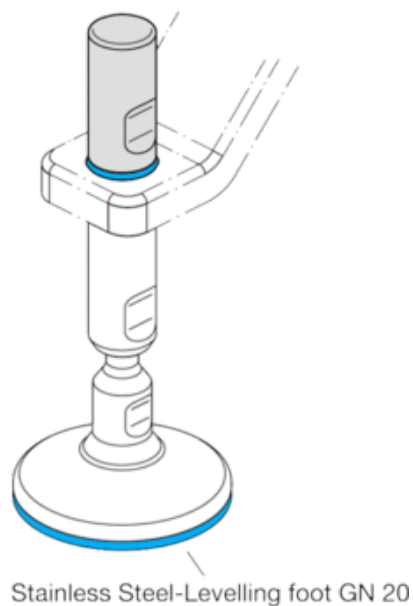

A/F	= 27
d1	= M 20
d2	= 32
d3	= 32.8
l	= 68
t1	= 25.5
t2	= 60
Weight in (g)	= 272